

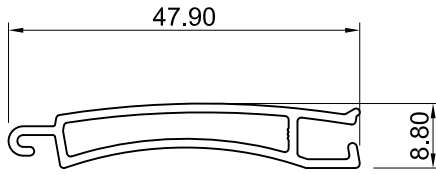

**ES**

PERFIS PARA ESTORES

 **PORTALEX**



**ES 00**

PESO 0,344 KG/M  
 ANOD. 0,138 M2/M  
 POL. 0,089 M2/M

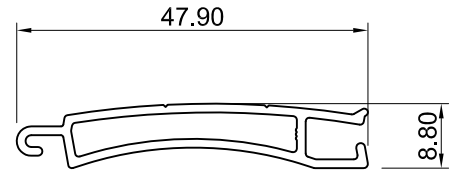

**ES 10**

PESO 0,344 KG/M  
 ANOD. 0,138 M2/M  
 POL. 0,089 M2/M

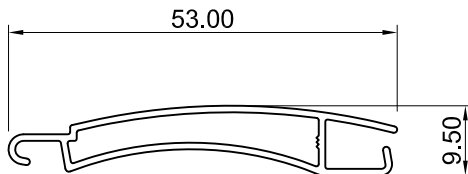

**ES 93**

PESO 0,283 KG/M  
 ANOD. 0,151 M2/M  
 POL. 0,117 M2/M

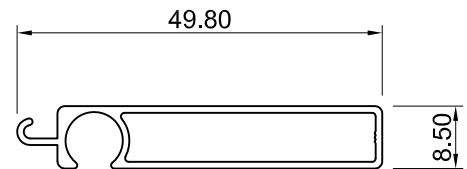

**ES 13**

PESO 0,289 KG/M  
 ANOD. 0,136 M2/M  
 POL. 0,084 M2/M

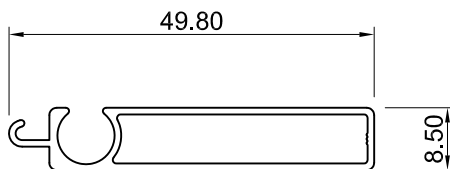

**ES 33**

PESO 0,289 KG/M  
 ANOD. 0,136 M2/M  
 POL. 0,084 M2/M

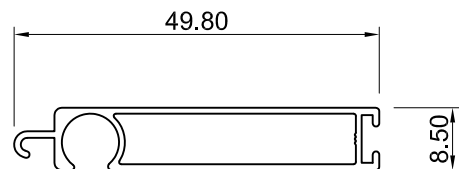

**ES 43**

PESO 0,274 KG/M  
 ANOD. 0,147 M2/M  
 POL. 0,089 M2/M

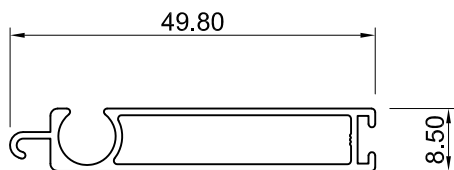

### ES 83

PESO 0,299 KG/M  
ANOD. 0,147 M2/M  
POL. 0,089 M2/M

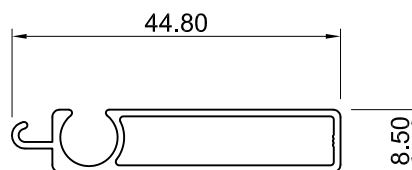

### ES 53

PESO 0,269 KG/M  
ANOD. 0,129 M2/M  
POL. 0,074 M2/M

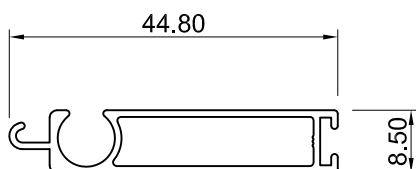

### ES 63

PESO 0,274 KG/M  
ANOD. 0,137 M2/M  
POL. 0,074 M2/M

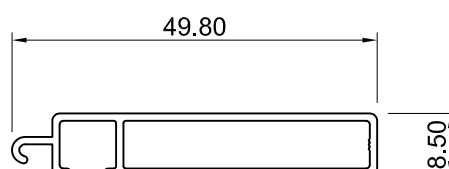

### ES 3N

PESO 0,299 KG/M  
ANOD. 0,139 M2/M  
POL. 0,084 M2/M

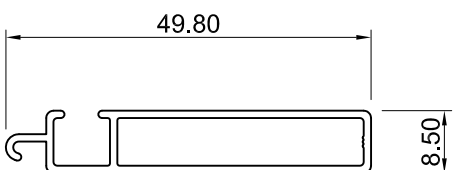

### ET 13

PESO 0,299 KG/M  
ANOD. 0,139 M2/M  
POL. 0,084 M2/M

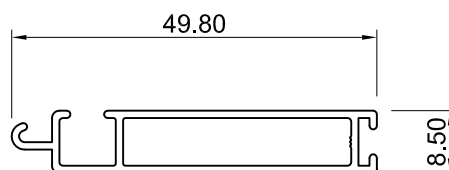

### ET 43

PESO 0,308 KG/M  
ANOD. 0,150 M2/M  
POL. 0,084 M2/M

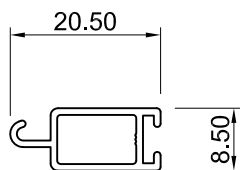

### ES 73

PESO 0,133 KG/M  
 ANOD. 0,072 M2/M  
 POL. 0,030 M2/M

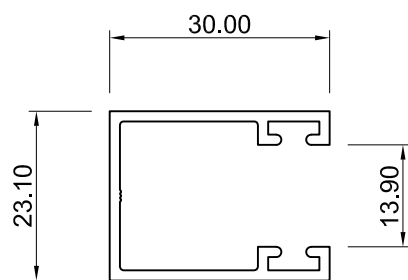

### ES 05

PESO 0,378 KG/M  
 ANOD. 0,200 M2/M  
 POL. 0,070 M2/M

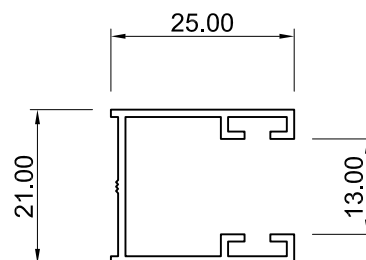

### ES 15

PESO 0,244 KG/M  
 ANOD. 0,183 M2/M  
 POL. 0,058 M2/M

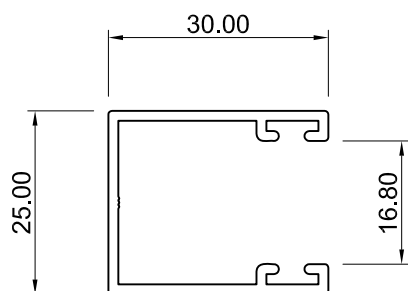

### ES 25

PESO 0,363 KG/M  
 ANOD. 0,200 M2/M  
 POL. 0,068 M2/M

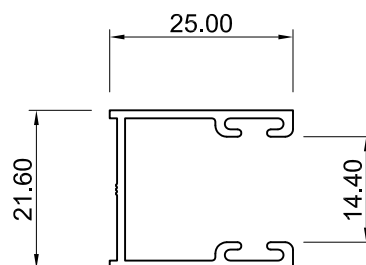

### ES 45

PESO 0,264 KG/M  
 ANOD. 0,172 M2/M  
 POL. 0,057 M2/M

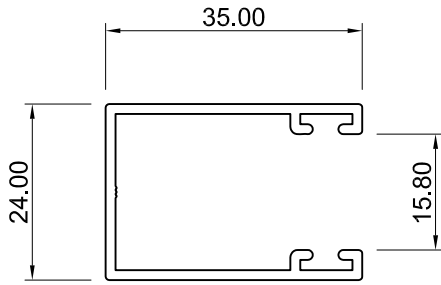

### ES 65

PESO 0,395 KG/M  
ANOD. 0,218 M2/M  
POL. 0,078 M2/M

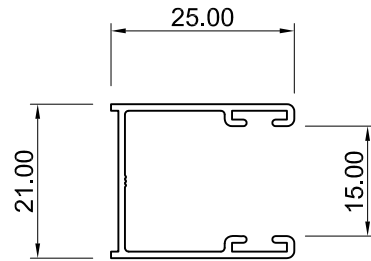

### ET 05

PESO 0,207 KG/M  
ANOD. 0,168 M2/M  
POL. 0,055 M2/M

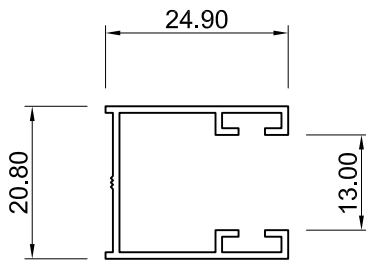

### ET 15

PESO 0,218 KG/M  
ANOD. 0,183 M2/M  
POL. 0,058 M2/M

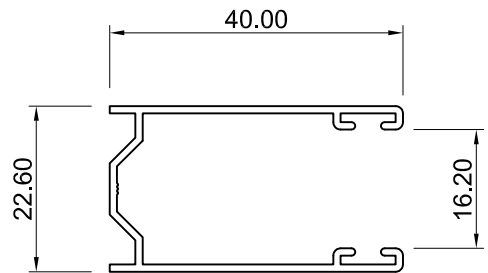

### ET 55

PESO 0,321 KG/M  
ANOD. 0,239 M2/M  
POL. 0,084 M2/M

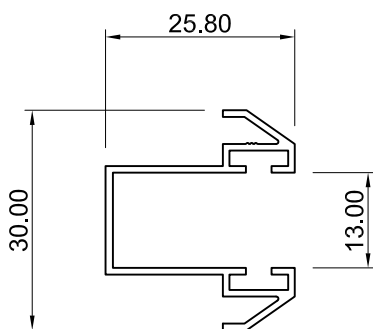

### ES 35

PESO 0,263 KG/M  
ANOD. 0,211 M2/M  
POL. 0,030 M2/M

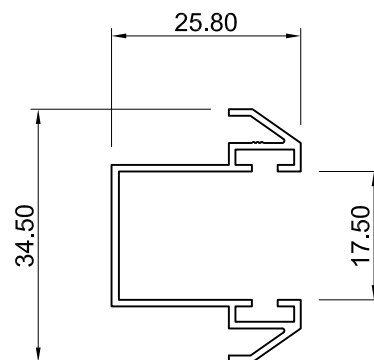

### ES 55

PESO 0,275 KG/M  
ANOD. 0,220 M2/M  
POL. 0,030 M2/M

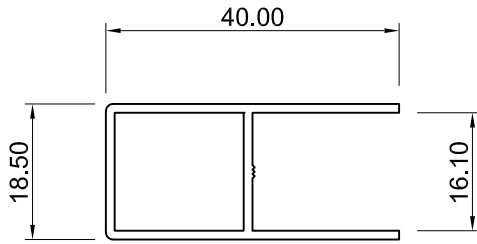

**ES 06**

PESO 0,364 KG/M  
 ANOD. 0,157 M2/M  
 POL. 0,080 M2/M

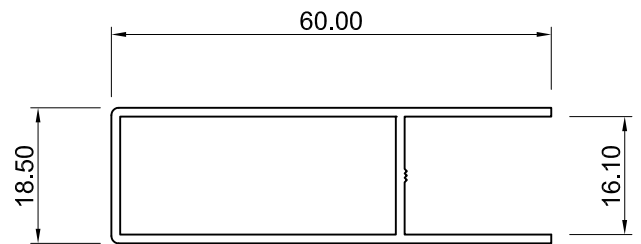

**ES 16**

PESO 0,492 KG/M  
 ANOD. 0,197 M2/M  
 POL. 0,120 M2/M

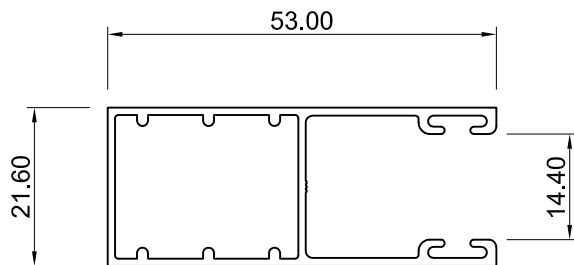

**ES 08**

PESO 0,497 KG/M  
 ANOD. 0,232 M2/M  
 POL. 0,113 M2/M

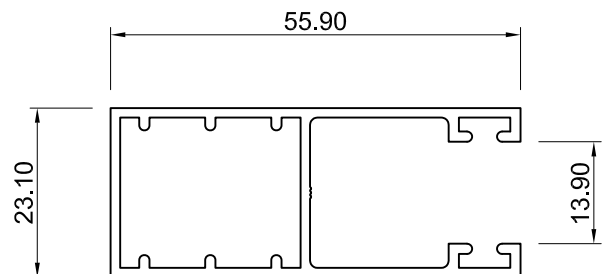

**ES 18**

PESO 0,650 KG/M  
 ANOD. 0,253 M2/M  
 POL. 0,121 M2/M

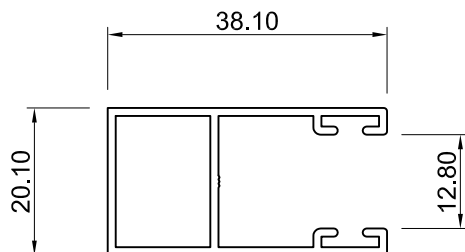

**ES 26**

PESO 0,387 KG/M  
 ANOD. 0,198 M2/M  
 POL. 0,083 M2/M

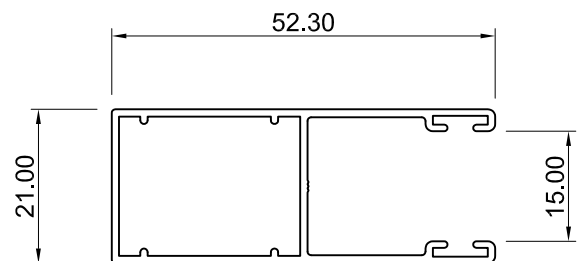

**ET 08**

PESO 0,437 KG/M  
 ANOD. 0,225 M2/M  
 POL. 0,110 M2/M

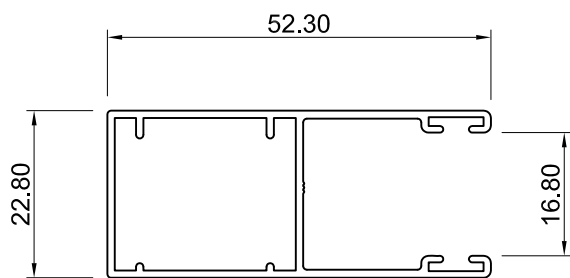

### ET 18

PESO 0,456 KG/M  
 ANOD. 0,228 M2/M  
 POL. 0,110 M2/M

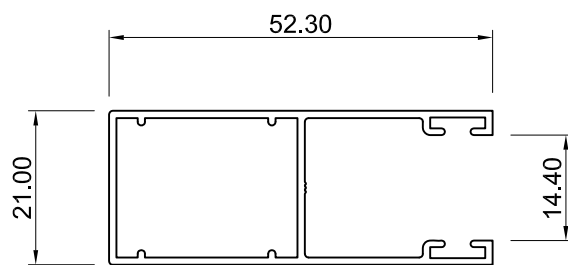

### ET 28

PESO 0,433 KG/M  
 ANOD. 0,229 M2/M  
 POL. 0,112 M2/M

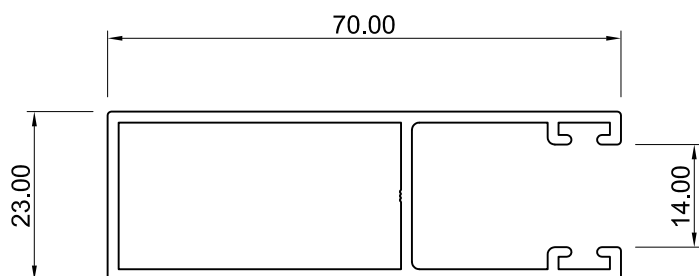

### ES 28

PESO 0,800 KG/M  
 ANOD. 0,276 M2/M  
 POL. 0,149 M2/M

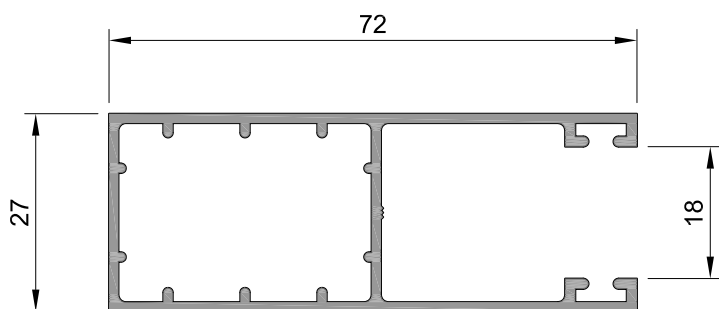

### ES 38

PESO 0,000 KG/M  
 ANOD. 0,000 M2/M  
 POL. 0,000 M2/M

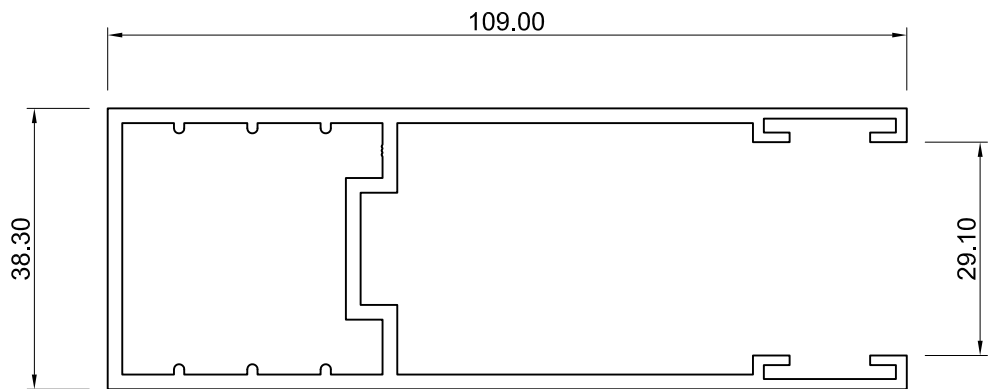
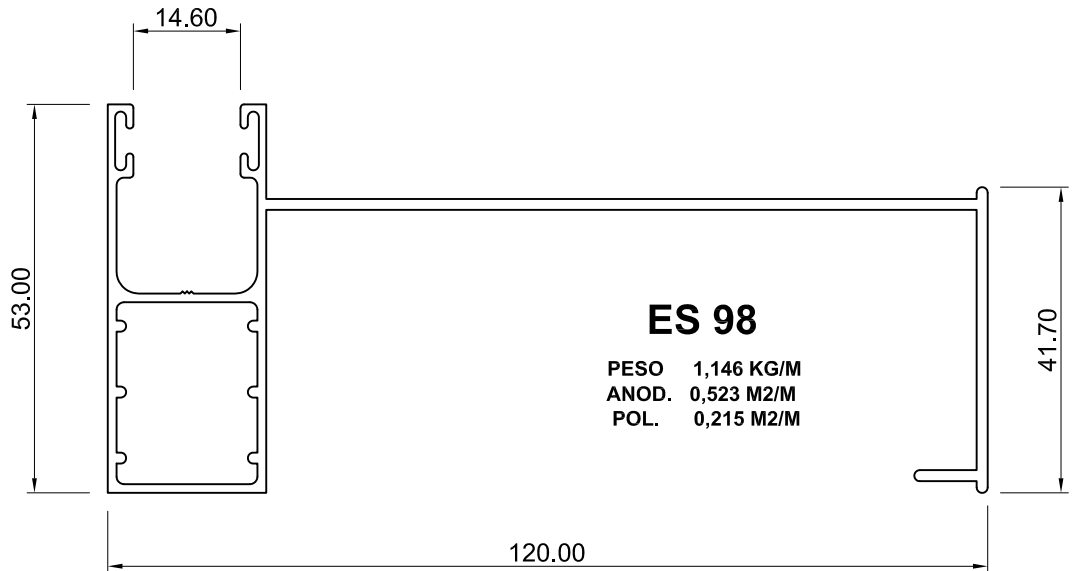

**ES 99**

ANOD.	0,495 M2/M
PESO	1,067 KG/M
POL.	0,227 M2/M

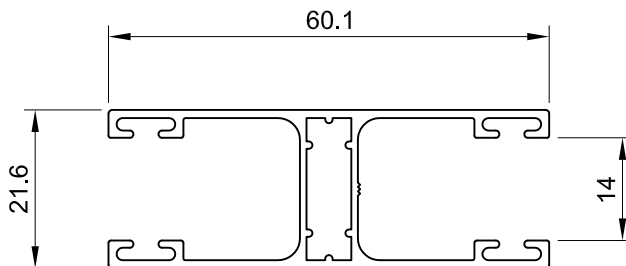

**ES 09**

PESO	0,601 KG/M
ANOD.	0,332 M2/M
POL.	0,135 M2/M



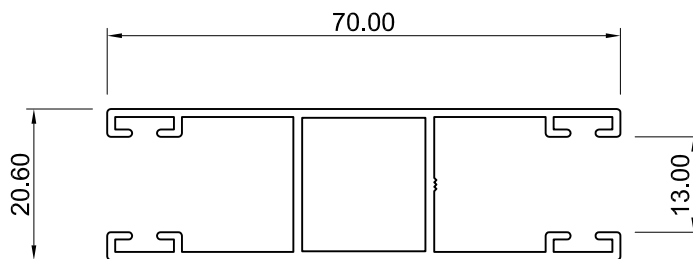

**ES 19**

PESO 0,655 KG/M  
 ANOD. 0,358 M2/M  
 POL. 0,155 M2/M

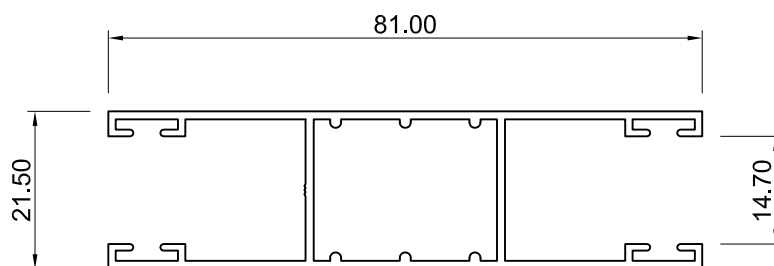

**ES 29**

PESO 0,715 KG/M  
 ANOD. 0,385 M2/M  
 POL. 0,176 M2/M

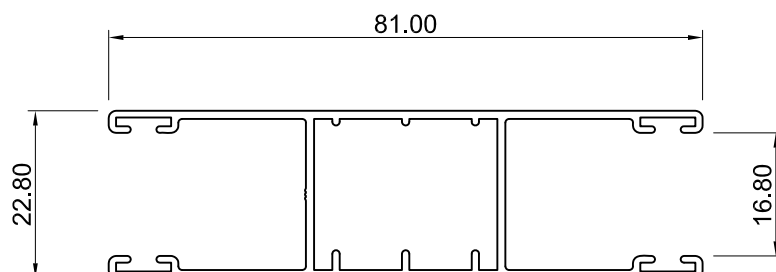

**ET 29**

PESO 0,687 KG/M  
 ANOD. 0,370 M2/M  
 POL. 0,172 M2/M

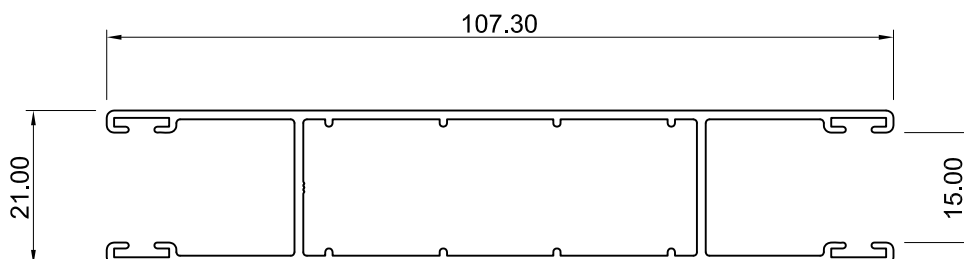

**ET 37**

PESO 0,886 KG/M  
 ANOD. 0,412 M2/M  
 POL. 0,226 M2/M

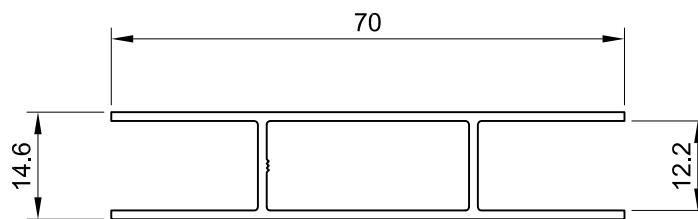

### ES 07

PESO 0,535 KG/M  
ANOD. 0,249 M2/M  
POL. 0,140 M2/M



### ES 17

PESO 0,496 KG/M  
ANOD. 0,237 M2/M  
POL. 0,120 M2/M

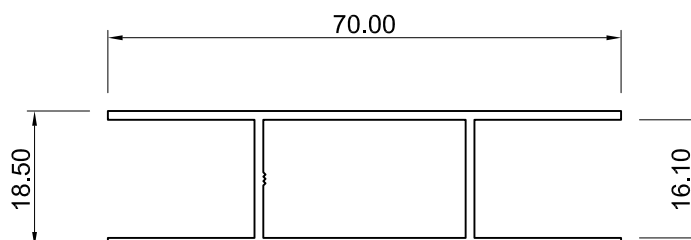

### ES 27

PESO 0,559 KG/M  
ANOD. 0,257 M2/M  
POL. 0,140 M2/M



Estrada de São Marcos, 23  
2735-521 Cacém – Portugal  
E: [portalex@portalex.eu](mailto:portalex@portalex.eu)  
T: +351 210 412 500  
F: +351 210 412 507

[www.sosoares.pt](http://www.sosoares.pt)